

DUALTRON *RAPTOR II*

The dream of electric technology

PERSONAL MOBILITY User Manual



Company Introduction

Minimotors Co. LTD., is a company that manufacture and distribute personal mobility with a professional production system since 1999.

Minimotors Co. LTD., has been making the electric mobility brand 【 DUALTRON】 to meet the world people with the aim of making more innovative, more sensuous, and more convenient personal mobility from 1999 to the present and making a product that is loved by people in the world. Minimotors Co. LTD., Is doing its best to become the world best electric mobility company.



Brand Introduction

'DUALTRON' brand is a worldwide electric scooter brand name that Electier Co. LTD., designed.

'DUALTRON' is a breakthrough product that combines the world's first dual drive system and the new rubber suspension technology (patent application). It is a proud Korean luxury brand that has won the world electric scooter market exported to more than 20 countries.



✓ Please read the user manual carefully.

Do not use the product until you understand its functions.
Do not rent the product to anyone who can't operate the product.

*For the first time, the user should use it with a slow speed' for safety.

Dualtron raptor II user manual contents **DUALTRON RAPTOR II**

01. Safety guidelines and restrictions	04
02. Product structure	06
03. Name of each part	07
04. Product components	08
05. How to use the product	09
06. How to use the instrument panel	12
07. How to use the charger correctly	14
08. Safety precautions for Lithium-ion battery	15
09. Safety guidelines before driving	16
10. Maintenance	17
11. Important checklist	18
12. Product specifications	20

Before Reading Manual

This manual contains important information to help you to use your product more safely. For safe use, it is marked as 'Danger', 'Caution' and 'Warning' depending on the degree of danger and the meaning is as below.

Danger: Indicates a hazardous situation that could be a result of serious injury.

Warning: Indicates a potentially hazardous situation that could be a result in light injury.

Caution: Indicates a potentially hazardous situation that could be a result in serious injury.



✓ Please read this manual carefully
before using this product

1) Safety guidelines and restrictions

* Even if the it is within the warranty period, you may be liable for any accident caused by any of the following causes.



1. Be careful of water!

This product and components are not waterproof. Don't let the water get into the product and components.

* Never use it, if the road is wet due to the rain, snow, hailstone.

* If you wash or spread water to electric devices, it can result in malfunction or fire.



2. Beware of folding and spinning parts!

If parts of the body, as a finger or hair, get caught in the spinning or folding parts of the product, this may lead to severe injuries. Please be careful.



3. No acrobatics

Stunts and jumps such as jumping and dropping are prohibited as they can cause a great impact on the product and can cause of malfunction and accidents.



4. No companion boarding

This product is intended for one adult only, so children, infants, or two people are prohibited from boarding.



6. Comply with the related laws

Unlicensed, driving after drinking, loading cargo on the scooter is prohibited. (More than bike or bicycle license is required)

Please comply with the Road Traffic Act and related laws and regulations according to the place of use.



5. Don't tune by yourself

Do not open or tune the electric parts (battery, controller or motor system).



7. Beginners and seniors are encouraged to use at low speed

Beginners who are not accustomed to use the product, seniors and others should avoid high speed mode driving and recommend low speed driving.

In addition, please use after practice how to ride safely in a wide place.



8. Do not sudden brake with front brake

If there is a risk of overturning, sudden deceleration should be done safely. Do not apply any unusual behaviors or artificial forces, such as stopping with your feet.



9. Do not accelerate downhill

Slow down at downhill. When reducing the speed, to prevent brake overheat, use the brakes properly to reduce the heat on the disk with proper brake use.



10. Do not drive on steep slopes

Acceptable gradeability is different for each product. Excessive hill roads exceeding the specification may cause damage to the product (parts) due to temperature cut, overcurrent or low voltage cut, which may cause the product to malfunction.



11. Safety warning when lifting the product

If the product is lifted by holding only the handle, there is a possibility that the product may be damaged due to deformation of the folding part due to load or movement of the product. When lifting the product, be sure to hold the product's body (footrest) with one hand and hold the handle with the other hand so that you do not get hurt in your back or knees.



12. Be sure to wear safety equipment

For the safety of passengers, be sure to wear a full face helmet and the other protective gear (knee, elbow, hand, upper body) and do not wear shoes such as slippers, high heels that interfere with driving.

2) Precaution before driving

1. Night driving should be avoided in any case, be sure to wear helmets and other guards (knees, elbows, hands, upper body, etc.) and drive safely.
2. Select the mode that suits you and drive. In order to cope with the sudden situation, exercise to slow down to hold the brake at all times.
3. When turning left / right, slow down to avoid danger of overturning or slipping. And then slowly turn safely.
4. To go to backward, it is safe if you getting off from the product after stopping before moving.
5. It is prohibited to use in a slippery place, a crowded place, a steep slope, roads with a risk of accident, uneven road.
6. When crossing a pedestrian crossing, get off from the product for pedestrian safety.
7. Do not drive in a threat any other means of transport, such as animals, pedestrians, bicycles, motorcycles, cars, etc.
8. If you pass the speed bumps and obstacles, be sure to slow down.
9. When decelerating or braking, do not stop with using foot, but stop with using brake appropriately.
10. Be careful that there is a risk of burns due to heat from motor and brake (especially disk rotor) after driving.
11. It is prohibited to drive with all the way by holding the handle with one hand.
12. Do not ride or drive when the kick stand is down.

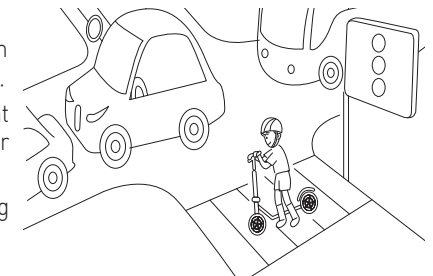

Product structure

Product size

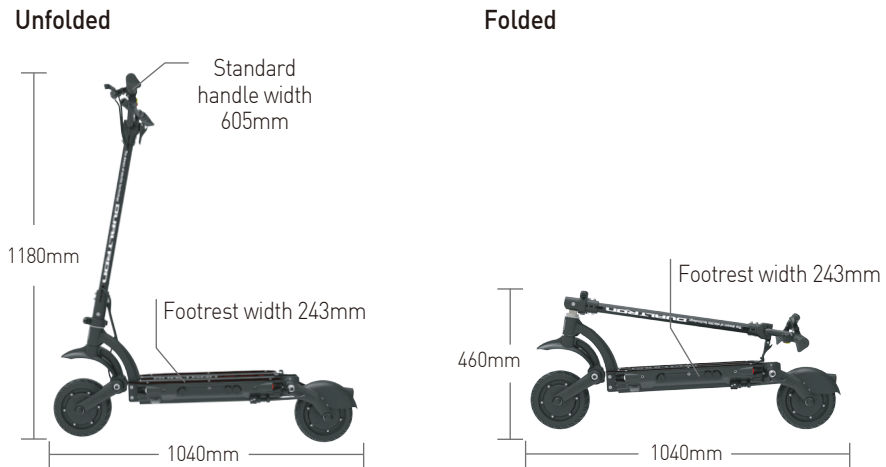

* Errors may occur depending on the measurement method.

Handle

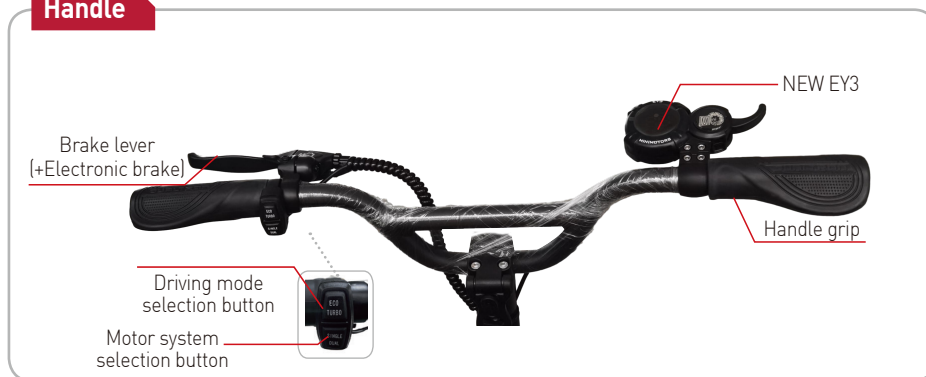

Name of each part

DUALTRON RAPTOR II

Body frame





Checking the components inside of the box

Top : Default battery charger(2A), Default tool, User manual
 Bottom : Body(Lithium battery included)

Ejecting the product number.



Do not hold the handlebar only when lifting the product from the box. Please be careful that the fixing slide of the folding part may be damaged, and a safety accident such as a part of the body may be caught. Therefore, when lifting the product, it is necessary to raise the handle bar first, and then slowly lift the body (footrest) of the product with both hands and do not damage the folding part

Make a note of the serial number.



The serial number can be used to check information such as date of purchase, warranty period, etc., and product information can be checked even if the product is lost or stolen. (May vary depending on branch office situation.)

Assembling of the instrument panel, brake



-Locate the instrument panel and tighten the fixing bolts.



-Adjust the position of the brake and tighten the fixing bolts with a 5mm hexagon wrench.

1) Productun folding



1. Raise the handle post(Steering tube)

Release the QR lever, raise the locking slide upwards, raise the steering tube, then lower the locking slide downward.



2. Raising handle post(Steering tube)

When unfolding the steering tube, raise the handlebar while pushing the deck with foot, and then lower the loking slide down completely and tighten the right finishing screws.



3. Fixing the folding part

When the QR lever is locked inward as shown in the picture, the handle unfolding is completed. If the folding lever is not completely locked, a safety accident while driving can be occurred. Before and after running, always check if there is a play in the folding part, and a folding part or handle part, the bolt&nuts of all the fixing parts of the product are properly tightened and the fastened parts are not loosened.

2) How to start



Step1. Turning on the Power Button

When turning on the product, you can press and hold the Power Button to turn on the scooter. When driving is finished, press and hold the Power Button to turn off the scooter.

Step2. Setting proper speed gear.

Before driving, you can press the Power Button to adjust the speed gear.



Step3. Stance for driving

After tilting the kickstand, find a stable position on the footrest and then hold the handle grip comfortably. Be careful not to raise your foot on the rear fender.

Step4. Acceleration and deceleration

Acceleration can be performed by using the throttle of the instrument panel while driving, and the deceleration or stop can be performed by holding the brakes on the handle.

Tip



Checklist before turning on the product

Before turning on the product, turn on the power with the LED lamp turned off.



Before driving, be sure to check the folding part, the handle part, the part where the main fixing part of the product is fastened well. And check the position of the fixing slide, the QR lever locking status and the folding part fixing status.

Throttle malfunction caution

Regardless of whether the throttle is operated or not, the motor sensor may continue to operate, causing malfunctions such as sudden acceleration. In this case, holding the brake lever to cancel the operation. This phenomenon may be caused by corrosion of the throttling, immersion of the throttle, disconnection of the magnet, broken off levers, and breakage of the spring. Do not bounce the throttle lever strongly.

3) How to stop

Step1 Rear brake use

Be sure to use the rear brake first for decelerating when stopping while driving. For safe stop, it is necessary to practice slow down after deceleration with rear brake.



Step2 Driving mode and motor system selection



Step3 Deceleration and braking using electric brake

Set the use and strength of the electronic brake among the detailed functions of the instrument panel before driving. When the brake lever works, the electronic brake works together to increase the braking force.

Tip Check for safe braking

- For safe braking, check whether the brake lever and disc caliper connection (wire damage, external breakage, etc.) are damaged before and after driving, and check brake wear and looseness of brake inner core (Inner wire). In the case of hydraulic brakes.
- Due to various factors such as road surface condition and speed, it may not be possible to stop when brake is operated as expected. The electronic brake and EBS functions are auxiliary functions to further increase the braking force and used. The user should understand the function and expect the operation timing when use this function.

4) Product folding



1. Releasing fixing folding part

Unfold the QR lever outwards and pull the locking slide up, and then lay the steering tube in the direction of the arrow.



2. Folding handle post

When folding the steering tube, hold the post and lower it toward the deck. Raise the locking slide up and tighten the right finishing screws.



3. Fixing folding part

Fold the QR lever inward as shown in the picture and fix it to complete the product folding.

How to use the instrument panel



Dashboard

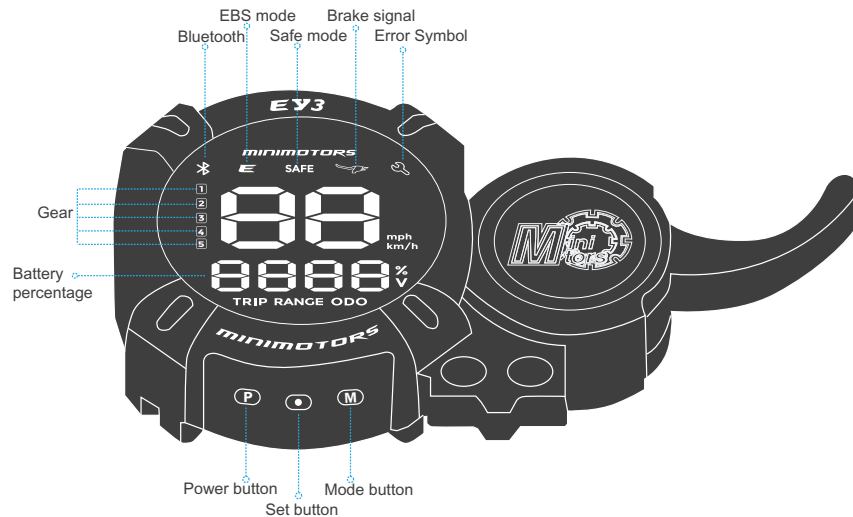

Symbol	Name	Meaning	Description
	Power Button	1.Press and hold the Power button to turn on/off the scooter. 2.Press the button to adjust the speed gear.	
	Set Button	1.Press and hold the Set button to enter/exit ECO mode. 2.Press the button to switch battery voltage/percent indication.	
	Mode Button	1.Press and hold the Mode button to enter/exit the mode setting,and automatically return to the main interface after 30s. 2.Press the the Mode button to switch ODO/time indication.(Time defaults)	
	Battery Display	The symbol displays the remaining battery power in battery bar.	
	PAS	Kick start,scooter cannot be directly accelerated to start,(Default OFF)	Set in P1 .When PAS turns on, PAS symbol will appear in the LCD screen.
	Starting Effect	Powerfully start and gently start selection.	Set in P2."0" means the most powerfully start,it will have a strong impact. "1" means 0.5s gentler start,"2" means 1s gentler start, and so on. "5" means the gentlest start. The default is 2,1s gentler start.
	EBS	EBS strength selection.	Set in P3. 0-5 strengths can be selected, 0 is the weakest, no EBS function, and 5 is the strongest. The default is 1.
	ABS	ABS function control.	Set in P4. 0 means function off and 1 means function on. The default is 0.
	Battery Save Mode	Battery Save Mode set.	Set in P5."1" means weak torque, about 50% of the maximum torque. "2" means normal torque, about 75% of the maximum torque. "3" means the maximum torque. The default is 2.
	Speed Limit	System speed control. (Percentage of max speed)	Set in P6.The parameter is adjustable from 5% to 100%, and the default is 100%.
	Protection (Password)	Password protection. (You need to enter the correct password to drive.)	Set in P7. Press the SET button to switch ON/OFF, and click the POWER button to confirm. If it is switched from OFF to ON, you need to enter the original password. If the original password is entered incorrectly, the setting is unsuccessful(The initial password is 0000). Note: If the user has turned on the protection and the app is certified as the owner, when the owner approaches the scooter,it can be unlocked automatically.

DUALTRON RAPTOR II

Symbol	Name	Meaning	Description
	Change Password	Reset a password.	Set in P8. Press the POWER to change the password. When the display shows 1, enter the initial password, press the POWER to confirm. And when the display shows 2, please enter the new password, and press the POWER to confirm.At this moment, the display will show 3, please enter the new password again and press the POWER. Then the Password is changed successfully. Note:The owner can connect to the APP directly without entering the password to unlock the scooter and reset the password on the mobile.
	Safe Mode	Prevent the scooter from starting when the accelerator is accidentally touched.	Set in P9.When the scooter is turned on and stays in the static state for N seconds (no operation, no speed), it will switch to the safe mode automatically. In SAFE mode, this symbol will appear on the screen. (N seconds ranges from 0 to 300 seconds. 0 seconds means SAFE mode is not enabled.)
	CCS	Drive at a constant speed without stepping on the accelerator or brake.	Set in P10. Turn on/off the cruise control mode. Default OFF. (The scooter maintains a fixed speed for more than 8s ,speed cruise work automatically)
	Prevent BMS CUT	When battery capacity less than 20%, scooter enters ECO mode automatically.	Set in P11. Turn on/off Prevent BMS CUT mode. The default is off. When scooter enter the ECO in this mode, the ECO can not be manually closed; if you want to manually close the ECO in the current mode, you need to close the Prevent BMS CUT mode first.
	Auto Power-off	Auto shutdown when the NEW EY3 is not operated.	Set in P12. Automatic shutdown time Settings adjustable range from 1-30 minutes. The default is 5 mins. Note: When the scooter has no operation and no speed, the timing starts.
	LCD Brightness	Adjust the LCD backlight brightness.	Set in P13. Adjust from 0 to 5, the default is 5.
	Imperial/Metric	Speed unit selection.	Set in P15. "0" means metric,it is km/h; "1" means imperial,it is mp/h. The default is 0.
	Wheel Diameter	Wheel diameter of the scooter.	Different scooters have different default diameters. They are set at the factory. Any modification is forbidden.
	Battery Voltage	Voltage of the scooter.	Different scooters have different default voltages. They are set at the factory. Any modification is forbidden.
	Pole Pairs	Motor pole pair number of the scooter.	Different scooters have different motor pole pair numbers. They are set at the factory. Any modification is forbidden.

Common Failures and Solutions

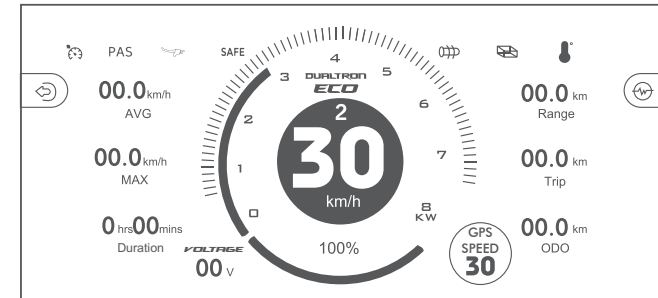

The new system for the EY3 screen LCD only displays the service symbol when the scooter breaks down. In this case, you need to check the APP to view the specific error code. The APP will display the following four error symbols. When there is a fault, please contact after-sales service or an authorized dealer.

Error Symbol	Possible causes	Solution
	Throttle failure	Please contact after-sales service or an authorized dealer.
	Motor failure	Please contact after-sales service or an authorized dealer.
	Controller failure	Please contact after-sales service or an authorized dealer.
	Over-temperature protection	Please try to apply heat dissipation for the scooter.

How to use a charger correctly

1) Basic charging method

1. Open the chargingport cap and connect it to the connector of the charger and connect it to the household outlet.
2. Charging status indicator
 - (Red) Charging
 - (Green) Charging complete
3. Be sure to close the chargingport cap when driving or storing except when charging.
4. When connecting the connector to the charging port, metallic sparks due to voltage difference may be splashed, but this is normal

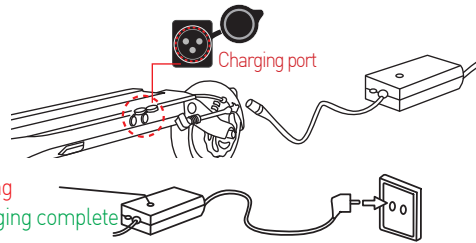

2) Basic charging method

* Failure of the charger and abnormal conditions can cause electric shock and fire. Learn the correct usage and prevent safety accidents in advance.

1. Manufacturers and sellers are not responsible for any problems arising from any disassembly, modification, or mixing with other chargers.		2. The charger is forbidden to be used in places subject to high humidity, heat, flammable materials, confined spaces, or where there is no ventilation such as in a car.	
3. The charger is not waterproof. It is thoroughly controlled to prevent moisture from entering the charger.		4. Children and pets should not be allowed to approach the charger when they come into contact with them, as they may cause an electric shock.	
5. If the charger lamp does not light, charger fall, strong external shock, long time charge, or cable cover damage, discontinue use immediately and contact the service center.		6. Unplug the charger when you are away from the home for long periods of time.	



7. Use only genuine charger.
8. Do not insert conductors into the charging port.
9. Do not touch the plug for about 10 seconds after unplugging the charger. There is a risk of electric shock from instantaneous discharge.
10. Do not remove the terminal during charging. Charge the internal circuit of the charger and cause malfunction.
11. Do not operate the product during charging.
12. Charging terminals should be firmly contacted during charging and should not be used if terminals are corroded or damaged.
13. When disconnecting the charger from the product, it is safe to hold the terminal without holding the wire.

Safety precautions for Lithium battery

DUALTRON RAPTOR II



- 1. Care** Lithium batteries should be protected from direct exposure to children and pets.
- 2. Performance**
 - ① Lithium battery is affected by external temperature. In winter, when the temperature is low, the performance of the battery is temporarily deteriorated and the mileage and power output is reduced.
 - ② Lithium battery has a characteristic that discharge performance is reduced by more than 15% when charging / discharging 300 times or more. If usage time is shortened due to long usage, it should be replaced with a genuine one through the nearest point.
- 3. Charging**
 - ① Lithium battery should be used only with genuine battery and charger supplied from the manufacturer. Any problems caused by use of battery made by the manufacturer, mixed use, or using the charger are not covered by the manufacturer.
 - ② Charging the lithium battery with a non-genuine charger may cause malfunction or fire.
 - ③ The lithium battery should be charged in a well-ventilated, dry place and around the charger in a place where there is no inflammable material.
 - ④ Lithium battery should be charged at 0 ~ 45 °C and discharged within -10 ~ 60 °C. Charging or discharging at a temperature outside this range may cause malfunction, fire or explosion.
 - ⑤ In case of moving from cold outside to warm indoor, please charge it after 1 ~ 2 hours. This is to prevent condensation from occurring inside the product due to temperature difference.
- 4. Storage**
 - ① Lithium batteries should be kept away from snow, rain and direct sunlight. Do not store or charge them in a trunk or hot room. Select a dry place and store at room temperature (10 ~ 20 °C).
 - ② When storing for more than 3 months, charge the remaining battery level to 70 ~ 80% (do not store full charge).
- 5. Trouble symptom, safety**
 - ① Lithium battery should be discontinued immediately if it is damaged or leakage of battery, sour odor, appearance deformation, etc., and contact the place of purchase to get technical support and service.
 - ② If overheat, smoke or ignition is detected in a product with lithium battery, immediately stop charging and use, move the product outdoors as soon as possible, and then use a fire extinguisher to evolve. Do not spray water or immerse the product in order to evolve, which is more dangerous.
 - ③ Lithium battery pack has very high energy density, so if you charge the battery for a long time in case of short-circuit, leakage, bad battery, etc., there is a possibility of ignition. Therefore, you should avoid charging for a long time without a person, and charging must be done while the person is aware that the risk of unexpected fire can be avoided.
- 6. Misuse** If the lithium battery is short-circuited or the polarity is changed, or if the battery is impacted, malfunction or fire may result. If you think that the battery has been impacted, you should stop charging and using it and visit the nearest point for inspection.
- 7. Water inflow** It should be controlled to prevent water inflow into the lithium battery. There is a risk of fire or electric shock if the charger is connected while moisture is present.
- 8. Caution** Disconnect the battery from the main unit and prohibit recharging, reinstalling, or using other applications.
- 9. Disposal** Disposal When disposing of the lithium battery, the battery should be separated from the product at the point of purchase or near the point so that the charge and discharge terminals are not short-circuited. Dispose of it as industrial waste when disposing of it.



Battery disassembly prohibited

Battery disassembly, modification and repair are not covered under warranty.

Safety guidelines before driving

1) Required checking before use

1. Check throttle and handle

- Operate the accelerator throttle lever about 2 ~ 3 times to check whether it returns to the home position.
- Be careful that excessive throttle leaning and manipulation of the throttle can cause malfunction due to internal parts damage.
- Check the fastening condition and clearance of the QR lever on the handle.



2. Check brake and cable

- The brake braking force is sufficient to check the operating condition. If the braking force is significantly lowered, use it immediately after inspection and action.
- Check that the brake pad is not worn, that the cable is not loose, that the cable is not damaged, or that there is no leakage in the case of hydraulic brakes.
- If there is an unusual feeling or noise during operation, check for breakage, wear and deformation of the inner wire of the brake cable.
- Check that the bolts and nuts of the brake fixing parts are not loose, and that the disc is not deformed or damaged.



3. Check tire pressure and uniaxial condition

- Check the front and rear tires for wear and punctures and check the proper air pressure [45 to 50 psi] for the tire. When the shortage of air is shortened, the possibility of puncture increases, so check always.
- It is necessary to judge the replacement time by observing the appearance of the tire such as tire damage, uneven wear.



4. Tightening check such as folding part and handle part

- Make sure that the bolts and nuts of all parts of the product are tight and free from loosening. Check the fastening condition and clearance of the folding and fixing parts of the handle (QR lever, fixed slide, hinge center bolt, headset nut, swing arm, etc.).



Danger

* If there is a folding clearance, it can be adjusted with a tongue bolt. However, if you pull it too hard, it will become stiff without a gap, but it may sound 'crackling'. In this case, if you adjust the tune bolt properly, the noise disappears and the clearance is also adjusted.



* In this case, stop driving immediately.

If you encounter any of the following situations while driving, stop driving immediately and contact your nearest branch or service center for proper measures. If you provide pictures and videos to get accurate diagnosis, professional counseling is available..

- Unusual heating of the motor
- Brake braking status error
- Error messages on the instrument cluster
- When the throttle is returned to its original position
- abnormal noise is generated
- Product smoke, ignition, sour odor
- When rain or wet with water or in a similar situation
- When other driving is judged to be unreasonable



Danger

Maintenance

DUALTRON RAPTOR II

2) Maintenance and self-maintenance

Electric products can be damaged by various factors. The life span of each part varies depending on driving habits and driving environment. Parts that exceed the service life may cause accidents. Let's manage various parts and prevent safety accidents in advance.



1. Check the replacement timing of consumable parts

※ The rubber inside the rubber suspension is cured as the consumable parts are used, and the performance of the suspension is slightly reduced because of the reduced elasticity.

- ① The components and suspension parts of the car swing arm, tires, tubes, wheels, bearings, headset bearings, discs, brake pads, cables and folding parts, various brackets and other consumable parts requiring periodic inspection and always check.

Fatigue failure parts and maintenance parts replacement cycle		
DUALTRON RAPTOR 2		
No.	Parts name	Replacement cycle / km
1	LOWER HINGE	2YEARS / 7,000
2	HIGHER HINGE	3YEARS / 20,000
3	HINGE BOLT	1YEAR / 5,000
4	STEERING TUBE	3YEARS/ 20,000
5	HANDLE STEM	3YEARS / 20,000
6	LOCKING SLIDE	2YEARS/ 10,000
7	BATTERY	2YEARS / 20,000
8	Other chassis components	If the exterior is damaged or deformed

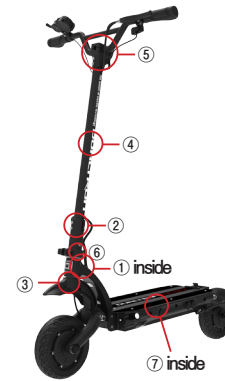

2. External damage inspection by driving environment



Caution

- ① Replace parts that may be damaged by external driving environment, such as deformation of parts, cracks due to compression, and signs of exceeding fine gold or life expectancy.
- ② If the product is exposed to strong sunlight for a long time, discoloration may occur.
- ③ In case of heavy driving such as normal jumps, slight impacts such as turning, collision, etc., when driving frequently or for a long time in a poor road condition or driving for thousands of kilometers or more, fatigue breakdown phenomena Please check and replace the parts replacement schedule for each product for safety.
- ④ Fatigue breakdown and maintenance parts may differ from the example conditions depending on the driving environment and the operating conditions. Also check parts other than the replacement cycle (maintenance parts) at all times to check for any signs of abnormality.

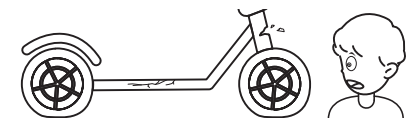

Important notice

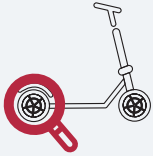

* Metal vibration may occur due to motor vibration, vibration of the brake disc and pad during the load section that accelerates during driving. (About 15 ~ 30Km, different for each product)

This is a phenomenon in which all revolutions (fans, automobiles, ships, etc.) are vibrating at a specific rotational frequency (rpm) rather than the product. However, if the continuous noise or metal noise is large, there is a possibility that the disk is bent and deformed.

* Please note that after running, there is a risk of burns due to the heat on the motor and brake (especially disk rotor) side.

* Remove the side cover for checking and repairing lights, charging sockets, power switch, etc. When assembling, fasten the product with a standard bolt. Be careful of the sheath of the wiring when tightening. When tightening with a bolt other than the rule bolt (long bolt)

The battery casing (battery cell) is critically damaged, causing a fire or safety accident.

※ Folding parts and joints where movement occurs due to product characteristics can naturally damage surfaces or painted surfaces during use, especially when operating in incorrect motion and shape.

3) Maintenance by self-maintenance

1. Brake adjustment method

As you continue to use the drum brakes, the brake pads become worn out and the gap between the pads.

If the braking force drops, use a hexagon wrench to loosen the brake wire bolt tight it.

If the brake lever too hard, we loose the nut



2. Variable rear rubber suspension system (patent pending) adjustment

Designed by MINI Motors, 5-step adjustable rubber suspension system allows you to adjust the suspension strength with rubber cartridge replacement (5 steps).

1. Remove the rear fender with a 3mm hex wrench, loosen the 12mm(motor sider), 12mm(swing arm side) nut, and then loosen the nut to remove the suspension arm.
2. Adjust the rubber cartridge replacement, and desired suspension strength.

■ Rubber Replacement (5th Stage): Replace Cartridge (Adjust height by weight)

Loosen both nuts with a wrench, loosen 3mm bolts and remove. Replace the cartridge when it is missing.

(It can be changed depending on weight and taste)

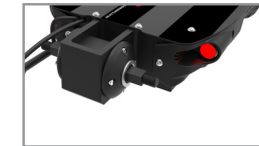
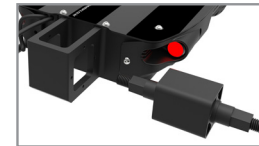

3. Align both suspension arms to the desired angle and reassemble using Loctite (screw lock).

Product Specification

DUALTRON RAPTOR II

Product Name	DUALTRON RAPTOR II	Note
Motor	900 W BLDC DUAL HUB MOTOR	
Battery type	Li-Ion battery pack	
Battery capacity	60V 14Ah	840Wh
Charging time (2A)	7hr	When using standard charger(2A)
Max mileage	45km	75±5kg load, 25km/h flat road continuous riding
Max Speed	Around 25km/h	Speed adjustment function on the throttle display. Single, Dual mode selection on the handlebar.(Single, Dual motor selection function)
Folding	Handle post two touch double folding	Patent pending
Gradeability	Around 60% (30°)	Weight, road condition, battery status, temperature can affect to the gradeability
Max load	100kg	
Product weight	Around 22.6kg	
Unfolding size	1040 x 605 x 1180mm	Length x Width x Height
Folding size	1040 x 605 x 460mm	Length x Width x Height
Dashboard	New EY3 display(DUALTRON APP available)	
Light	Dual LED lamp, brake light is built in	DC to DC converter is built in(12V 3A output)
Brake	Rear Drum brake and electric brake (Front & Rear)+ABS	Common use for front and rear wheel
Suspension	Rear-5 kinds of rubber cartridge replaceable design	Rubber cartridge normal is applied by default(Soft, medium soft, Hard, Medium hard cartridge are optional / Patented)
Tire	8" Solid wide tire	
Product material	Frame and handle: Aviation aluminum forging alloy, 6082-T6, Shaft: SCM440, Covers: Polypropylene	

*The specification can be changed by manufacturer without notice to improve the quality and safety for users.

*The distance can be affected by loaded weight, wind direct (wind speed), road condition, slope and tire condition.

MEMO

DUALTRON RAPTOR II

Electric Scooter

User Manual

ZHEJIANG DUALTRON ESCOOTER CO.,LTD.
No.111 Dengsheng Road Lanxi Economic
Development Zone Jinhua Zhejiang China

www.dual-tron.com

